



What is ME Series?

Modular Free-standing Enclosure Series (also called ME Series) is a knock-down main distribution board with flexible solutions. The protection category of this enclosure is IP55, which is suitable for both indoor and outdoor uses.

ตู้ตั้งพื้นนอกประสงค์

เป็นตู้จ่ายกระแสไฟฟ้าแบบน็อคดาวน์ที่ออกแบบมาเพื่อตอบสนองความต้องการที่หลากหลายของลูกค้า สามารถกันฝุ่นและละอองน้ำได้ในระดับ IP55 ซึ่งสามารถใช้ได้ติดตั้งได้ทั้งภายในอาคารและภายนอกอาคาร

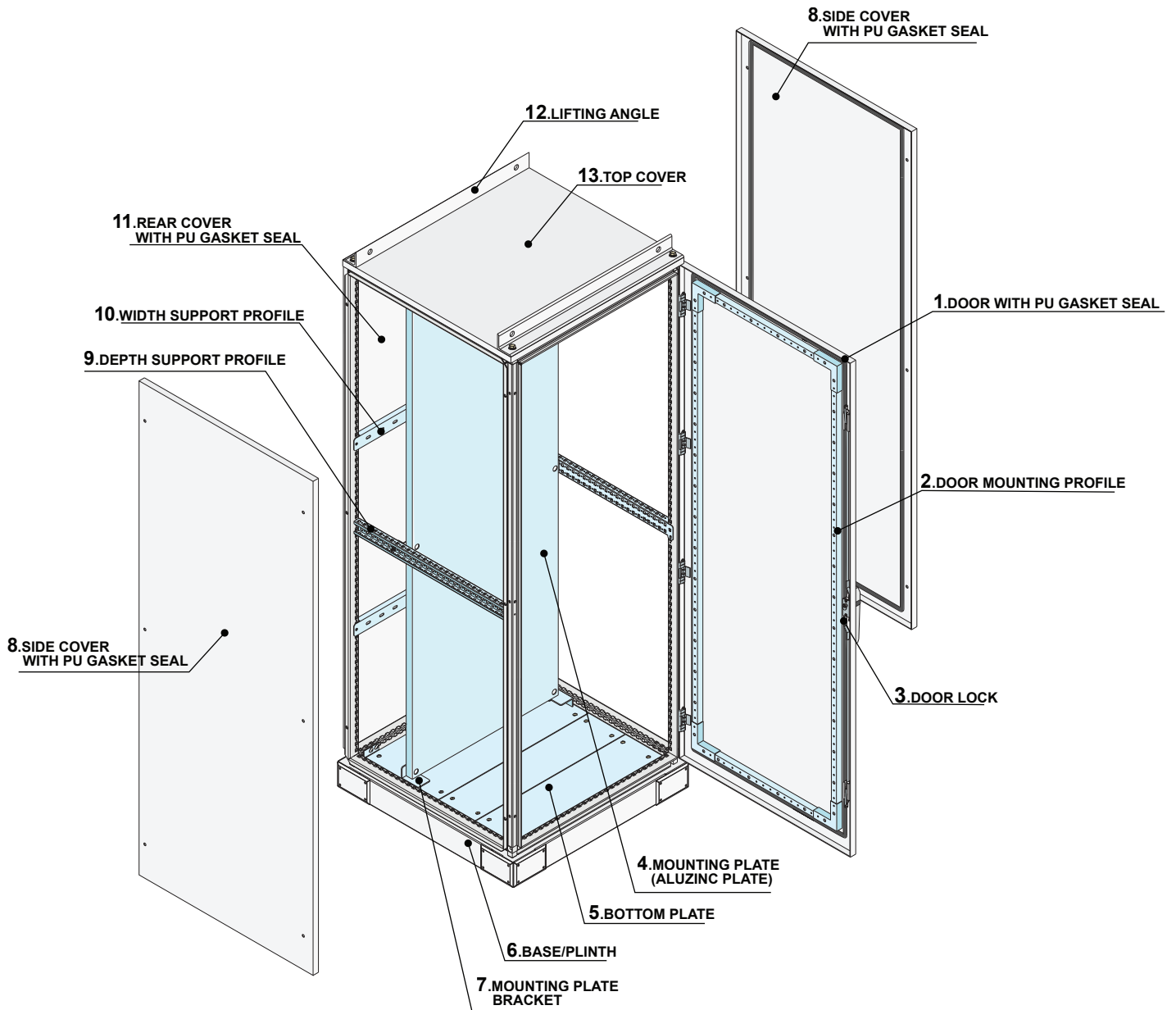



Specification

Material	Steel Sheet		Electro-Galvanized Steel (EG)			Aluminium-Zinc Coated Steel (Aluzinc)	
	Enclosure Frame (folded profile)	Rear and Side Cover	Door	Base Plinth		Mounting Plate	Bottom Plate
Corner				Side Plate			
Thickness (mm.)	1.5	1.5	2.0	3.0	2.0	2.0	1.5
Finished Surface	Polyester powder coated with UV Protection paint RAL 7035					Aluminium-Zinc Coated Steel (Aluzinc)	
Protection Rating	IP55						
On Request (Option)	Special sizes/ Special color/ Pre-punching						

Supply includes

1. Door with PU gasket seal
2. Door mounting profile
3. Door lock
4. Mounting plate (Aluzinc plate)
5. Bottom plates
6. Base/Plinth
7. Mounting plate brackets
8. Side covers with PU gasket seal
9. Depth support profiles
10. Width support profiles
11. Rear cover with PU gasket seal
12. Lifting angle
13. Top cover

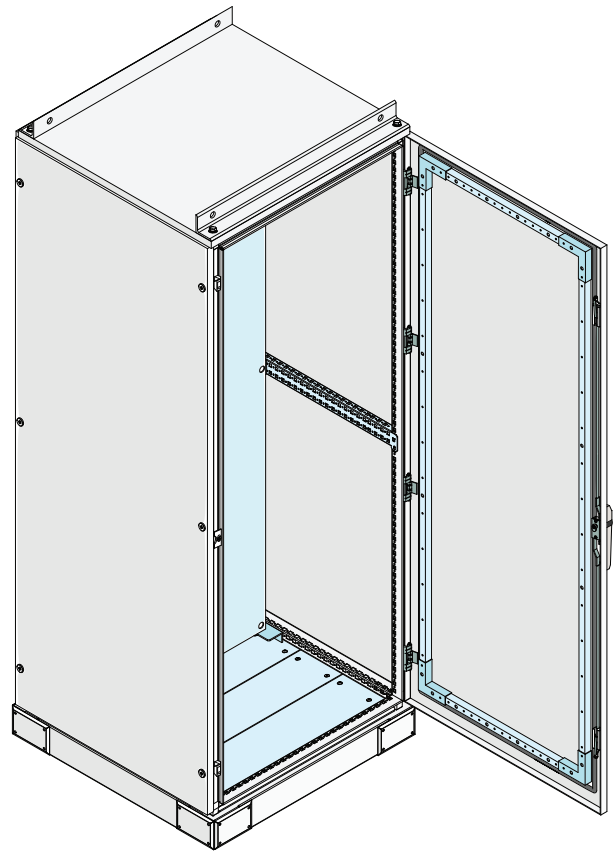
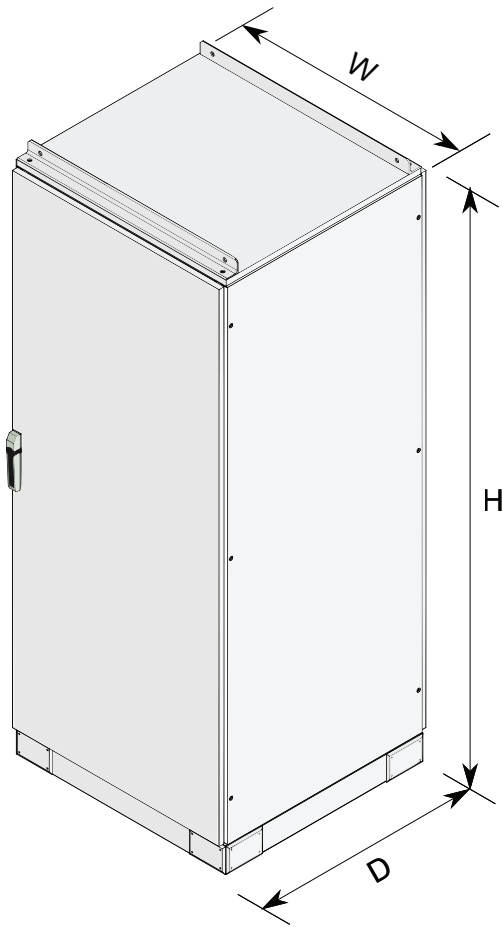

Single Door

รุ่น Model	ขนาดตู้ Enclosure Dimension (mm.)			เพลทยึดอุปกรณ์ Mounting Plate (Aluzinc Plate)		น้ำหนักตู้ Approx. Weight (Kg.)	ราคาต่อหน่วย Unit Price (Baht)
	Width (W)	Height (H)	Depth (D)	Dimension (mm.) W1 H1			
ME06.21.04	600	2100	400	495	1906	130	29,000.00
ME06.21.06	600	2100	600	495	1906	150	35,000.00
ME08.21.06	800	2100	600	695	1906	170	37,000.00
ME08.21.08	800	2100	800	695	1906	190	40,000.00

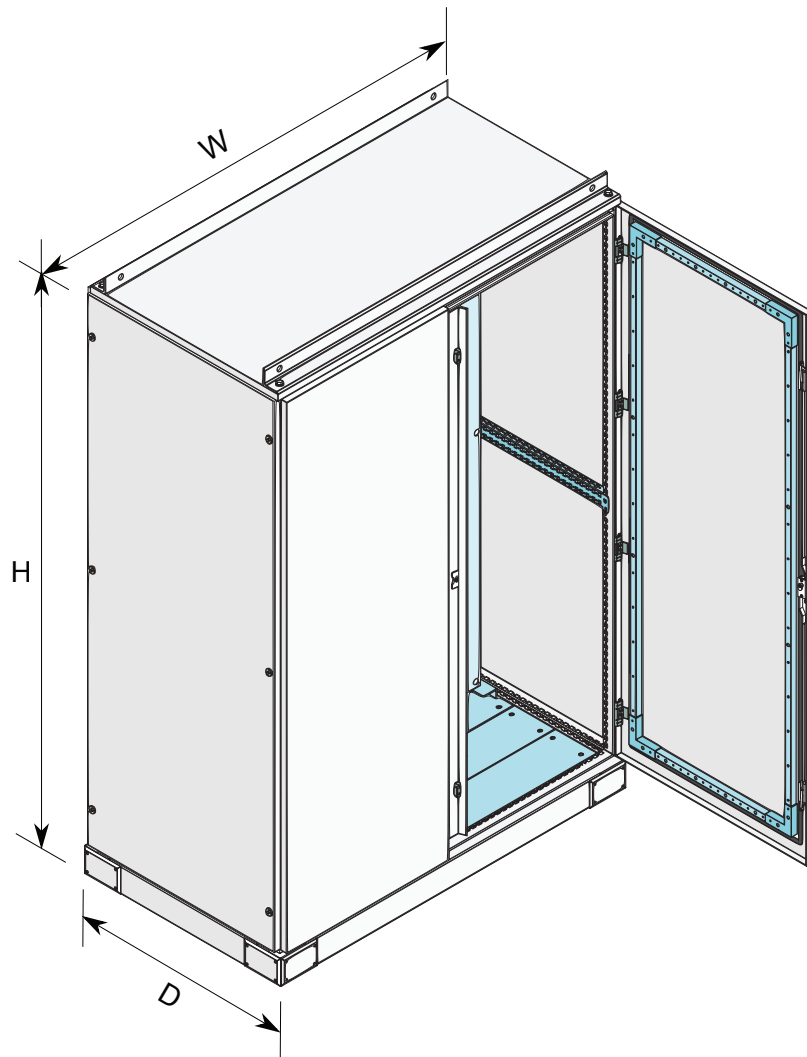

Double Door

รุ่น Model	ขนาดตู้ Enclosure Dimension (mm.)			เพลทยึดอุปกรณ์ Mounting Plate (Aluzinc Plate)		น้ำหนักตู้ Approx. Weight (Kg.)	ราคาต่อหน่วย Unit Price (Baht)
	Width (W)	Height (H)	Depth (D)	Dimension (mm.) W1 H1			
ME12.21.04	1200	2100	400	1090	1906	240	50,000.00
ME12.21.06	1200	2100	600	1090	1906	260	55,000.00
ME12.21.08	1200	2100	800	1090	1906	280	60,000.00

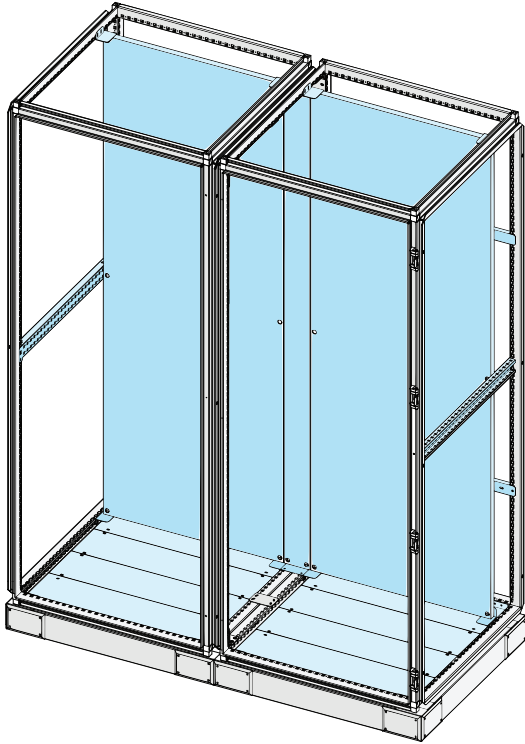

Enclosure extension.

- Enclosure frame
- Door
- Removable side cover, rear cover, and top cover

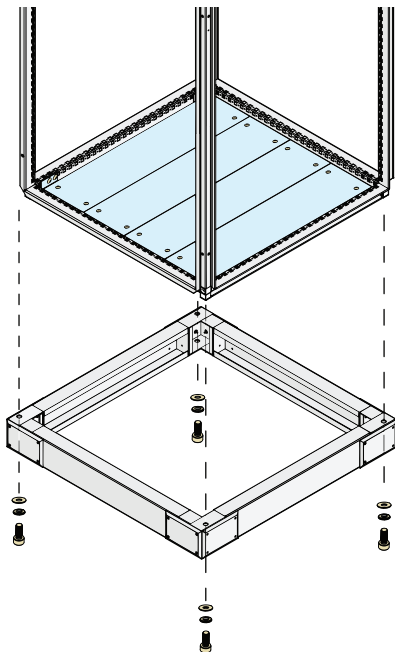

Add-on base to suit customer's requirement.

- H = 100 mm.
- H = 200 mm.

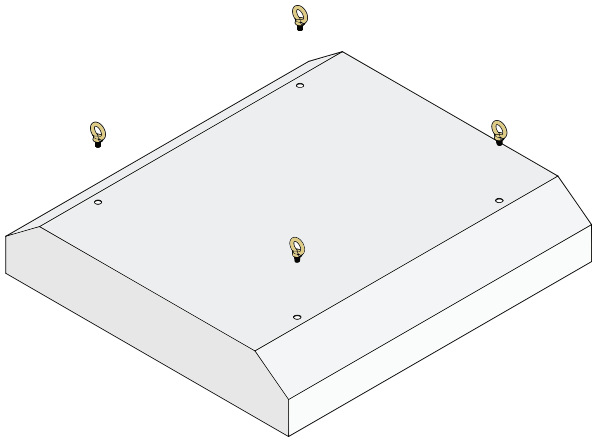

Add-on roof for outdoor uses.

Add-on accessories as per customer's requirement.

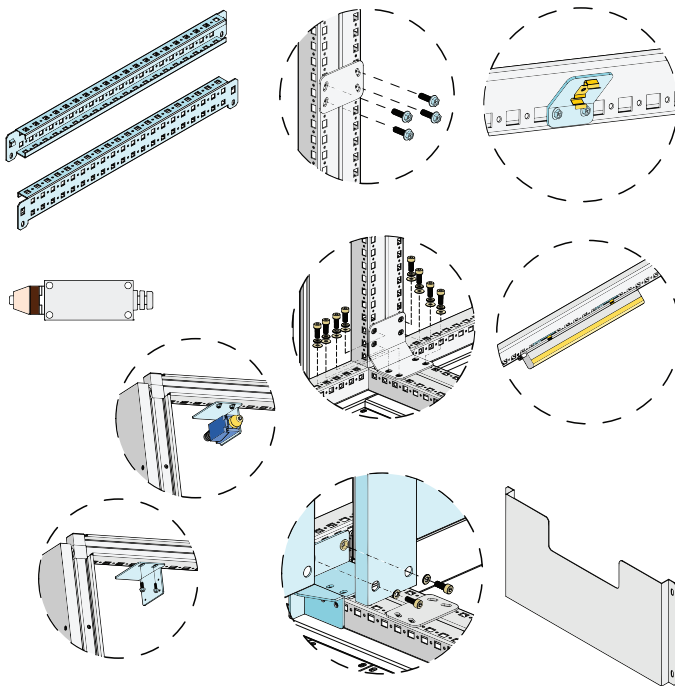

- Lifting angle / Eye bolt
- Mounting plate
- Depth support profiles
- Width support profiles
- Document pocket
- Bracket
- Door profile
- Support profile
- Door stopper
- Lighting system

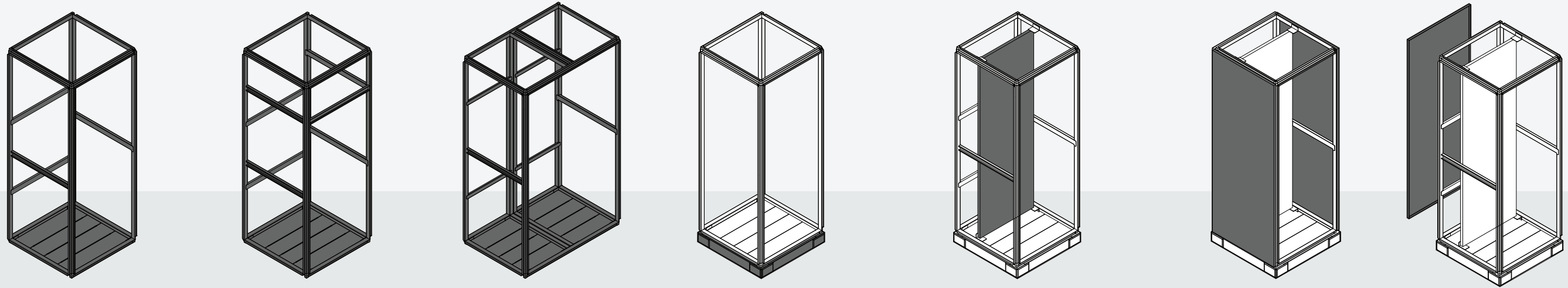

			Enclosure frame type 1	Enclosure frame type 2	Enclosure frame type 3	Base / Plinth		Mounting Plate			Side Cover		Rear Cover	
Width (W)	Height (H)	Depth (D)	Single door Model No.	Partial door Model No.	Double door Model No.	100 mm height Model No.	200 mm height Model No.	Full size for frame type 1	Partial for frame type 2	Full size for frame type 3	Full size	Ventilation holes	Full size	Ventilation holes
600	2000	400	MF-062004	MF-P-062004	-	B100-0604	B200-0604	P-06	PP-T-06	PP-B-06	SC-04	SC-V-04	RC-06	RC-V-06
600	2000	600	MF-062006	MF-P-062006	-	B100-0606	B200-0606	P-06	PP-T-06	PP-B-06	SC-06	SC-V-06	RC-06	RC-V-06
800	2000	600	MF-082006	MF-P-082006	-	B100-0806	B200-0806	P-08	PP-T-08	PP-B-08	SC-06	SC-V-06	RC-08	RC-V-08
800	2000	800	MF-082008	MF-P-082008	-	B100-0808	B200-0808	P-08	PP-T-08	PP-B-08	SC-08	SC-V-08	RC-08	RC-V-08
1200	2000	400	-	-	MF-122004	B100-1204	B200-1204	-	-	P2-12	SC-04	SC-V-04	RC-06	2 pc(s), RC-V-06 2 pc(s).
1200	2000	600	-	-	MF-122006	B100-1206	B200-1206	-	-	P2-12	SC-06	SC-V-06	RC-06	2 pc(s), RC-V-06 2 pc(s).
1200	2000	800	-	-	MF-122008	B100-1208	B200-1208	-	-	P2-12	SC-08	SC-V-08	RC-06	2 pc(s), RC-V-06 2 pc(s).

Specification

Material:

- Enclosure frame: Steel sheet, 1.5mm., folded profile
- Depth support: Aluminium zinc coated steel sheet, 2.0mm.
- Width support at rear: Aluminium zinc coated steel sheet, 1.5mm.
- Bottom plate: Aluminium zinc coated steel sheet, 1.5mm.

Finished surface:

- Enclosure frame: Polyester powder coated in RAL7035
- Depth support: Aluminium zinc coated steel
- Width support at rear: Aluminium zinc coated steel
- Bottom plate: Aluminium zinc coated steel

Supply includes:

- 1 Set of enclosure frame
- 2 pc(s) of depth support profile
- 2 pc(s) of width support profile
- 4 pc(s) of bottom plate
- Assembly parts

Technical details :

- Profile

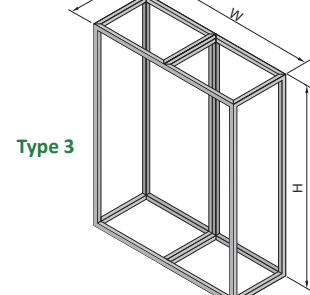
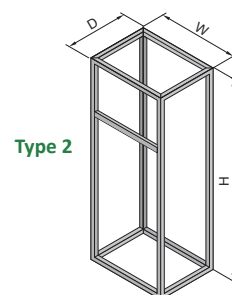
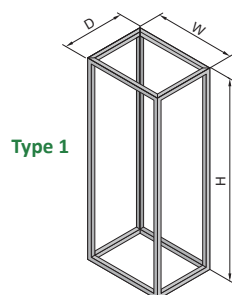
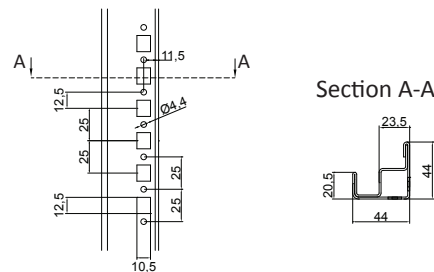

Material:

- Base corner: Steel sheet, 3.0mm.
- Base width and depth: Electro-galvanized steel, 2.0mm.

Finished surface:

- Base corner: Polyester powder coated in RAL7035
- Corner base cover: Polyester powder coated in RAL7035

Supply includes:

- 4 pc(s) of base corner
- 2 pc(s) of base width
- 2 pc(s) of base depth
- 8 pc(s) of corner cover
- Assembly parts

100 mm height

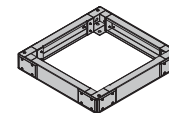

200 mm height

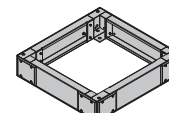

- Mounting plate: Aluminium zinc coated steel, 2.0mm.

- Mounting plate: Aluminium zinc coated steel

- 1 pc(s) of partition plate-A (for partial door)
- 1 pc(s) of partition plate-B (for partial door)
- Assembly parts

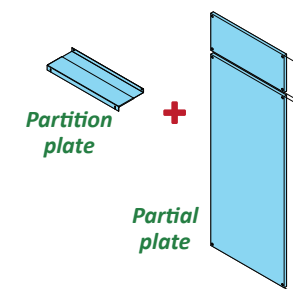

- Side cover: Electro-galvanized steel, 1.5mm.

- Side cover: Polyester powder coated in RAL7035

- Assembly parts

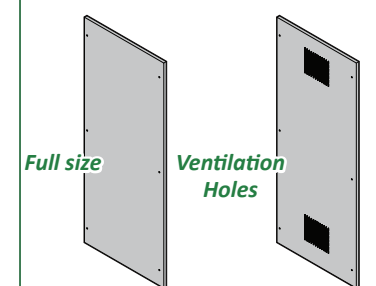

- Rear cover: Electro-galvanized steel, 1.5mm.

- Rear cover: Polyester powder coated in RAL7035

- Assembly parts

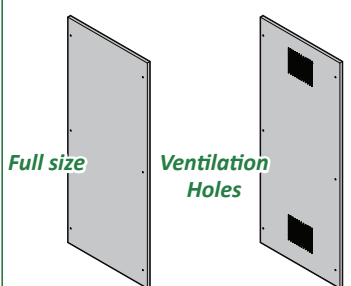

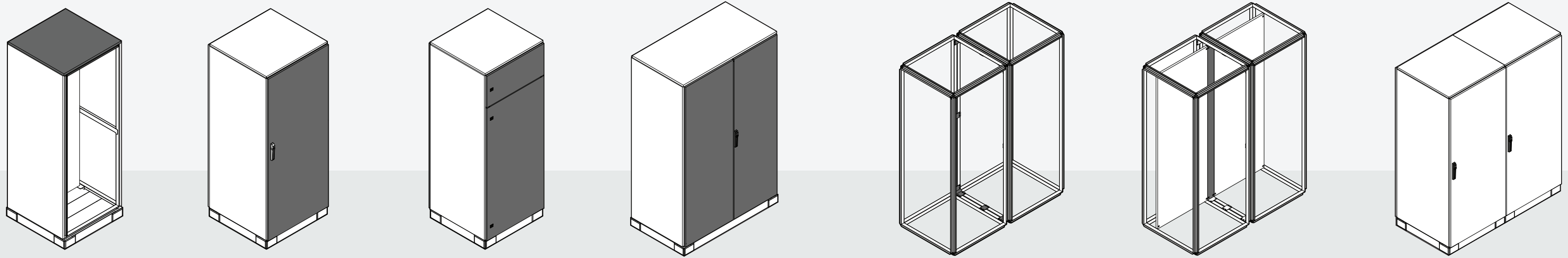

Top Cover		Single Door		Partial Door		Double Door	
Full size	for connector cut-outs	Full door for frame type 1	Door with glass for frame type 1	Top door for frame type 2	Bottom door for frame type 2	Left door for frame type 3	Right door for frame type 3
Model No.		Model No.		Model No.		Model No.	
TC-0604	TC-C-0604	D-06	DG-06	PD-T-06	PD-B-06	-	-
TC-0606	TC-C-0606	D-06	DG-06	PD-T-06	PD-B-06	-	-
TC-0806	TC-C-0806	D-08	DG-08	PD-T-08	PD-B-08	-	-
TC-0808	TC-C-0808	D-08	DG-08	PD-T-08	PD-B-08	-	-
TC-1204	TC-C-1204	-	-	-	-	ME-D-L-1220	ME-D-R-1220
TC-1206	TC-C-1206	-	-	-	-	ME-D-L-1220	ME-D-R-1220
TC-1208	TC-C-1208	-	-	-	-	ME-D-L-1220	ME-D-R-1220

Connector accessories set

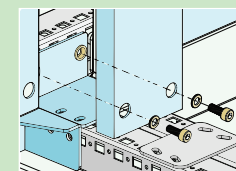

Mounting plate infill & Brackets

For a continuous mounting surface between connecting enclosure.

For enclosure frame: Height (mm.)	Pack of	Model No.	Unit Price (Baht)
2000	1 set	MF-01	1,405.00

Material

- Aluminium zinc coated steel, 2.0mm.

Supply includes

- Assembly screws

Note:

- 1 set consists of 1 piece of mounting plate infill and 3 pieces of the bracket.

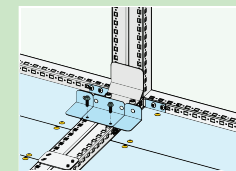

Bracket for connecting enclosure

For all-round installation on the baying joint flexible position to avoid collisions with installed equipment.

Description	Pack of	Model No.	Unit Price (Baht)
Flat Bracket	6 pc (s).	FB-01	405.00
Angle Bracket	4 pc (s).	AB-01	305.00

Material

- Steel sheet, 3.0mm.

Finished surface

- Polyester powder coated in RAL7035

Supply includes

- Assembly screws

Note:

- 1 pack is sufficient for one baying joint.

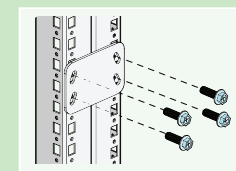

Rubber foam seal strip gasket

A waterproof seal strip for connecting the enclosure.

For enclosure frame: Depth (mm.)	Pack of	Model No.	Unit Price (Baht)
400	5.0m.	R-T3-04	285.00
600	5.5m.	R-T3-06	305.00
800	6.0m.	R-T3-08	335.00

Material

- EVA rubber, 3.0mm.

Note:

- 1 pack is for 1 connecting side.

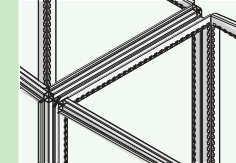
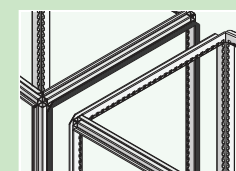
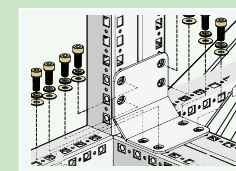

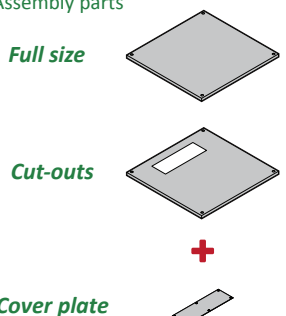
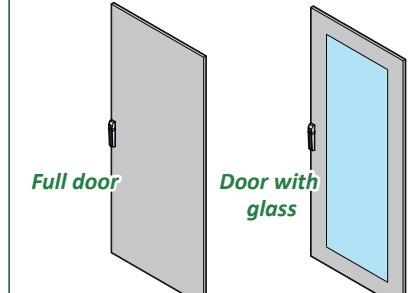
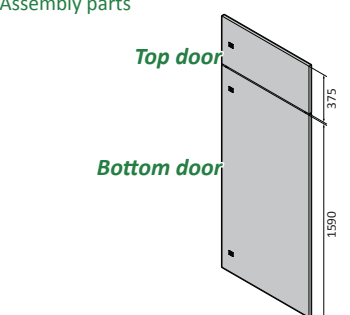
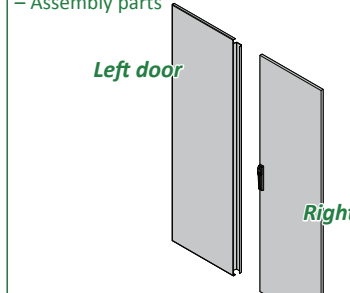
<p>– Top cover: Electro-galvanized steel, 1.5mm.</p>	<p>– Door: Electro-galvanized steel, 2.0mm. – Viewing window: Glass, 5.0mm.</p>	<p>– Partial door (top): Electro-galvanized steel, 2.0mm. – Partial door (bottom): Electro-galvanized steel, 2.0mm.</p>	<p>– Door (left): Electro-galvanized steel, 2.0mm. – Door (right): Electro-galvanized steel, 2.0mm.</p>
<p>– Top cover: Polyester powder coated in RAL7035</p>	<p>– Door: Polyester powder coated in RAL7035</p>	<p>– Partial door (top): Polyester powder coated in RAL7035 – Partial door (bottom): Polyester powder coated in RAL7035</p>	<p>– Door (left): Polyester powder coated in RAL7035 – Door (right): Polyester powder coated in RAL7035</p>
<p>– Cover plate (for cut-outs) – Assembly parts</p> 	<p>– 4 pc(s) of 110° hinges – 1 pc(s) of silver rod control lock – Assembly parts</p> 	<p>– 5 pc(s) of 110° hinges – 3 pc(s) of black square cylinder lock – Assembly parts</p> 	<p>– 8 pc(s) of 110° hinges – 1 pc(s) of silver rod control lock with handle lock – Assembly parts</p> 

Depth support profiles

For variable, individual interior installation of the enclosure frame at depth section.

Material

- Aluminium zinc coated steel, 2.0mm.

Supply includes

- Assembly screws

For enclosure frame: Depth (mm.)	Pack of	Model No.	Unit Price (Baht)
400	2 pc (s).	DCP-04	400.00
600	2 pc (s).	DCP-06	610.00
800	2 pc (s).	DCP-08	805.00

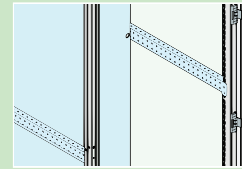
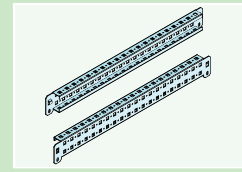

Width support profiles

For variable, individual interior installation of the enclosure frame at rear section.

Material

- Aluminium zinc coated steel, 1.5mm.

Supply includes

- Assembly screws

For enclosure frame: Width (mm.)	Pack of	Model No.	Unit Price (Baht)
600	1 pc (s).	WCP-06	170.00
800	1 pc (s).	WCP-08	230.00

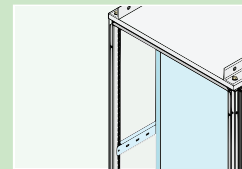
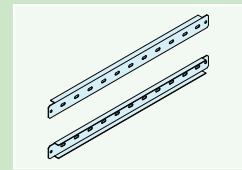

Door profile

For component installation or cable support behind the front door.

Material

- Aluminium zinc coated steel, 1.5mm.

Supply includes

- Assembly screws

For door: Width (mm.)	Pack of	Model No.	Unit Price (Baht)
600	1 pc (s).	DR-06	135.00
800	1 pc (s).	DR-08	200.00

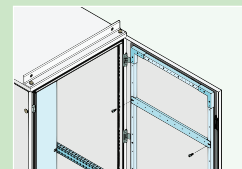
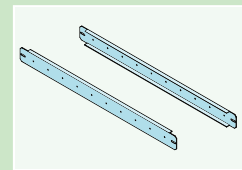

Document pocket

For document holder inside the panel, fastened to the door frame at any height.

Material

- Electro-galvanized steel, 1.5mm.

Finished surface

- Polyester powder coated in RAL7035

Supply includes

- Assembly screws

For door Width (mm.)	Pack of	Model No.	Unit Price (Baht)
600	1 pc (s).	DP-06	1,100.00
800	1 pc (s).	DP-08	1,400.00

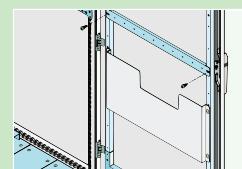
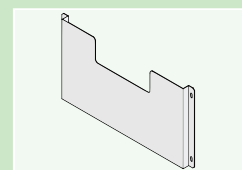

LED system

Panel lighting system

Supply includes

- Assembly screws
- Bracket light
- Bracket switch light

Description	Pack of	Model No.	Unit Price (Baht)
Panel light LED type 220V-50Hz 3.4W	1 pc (s).	LED-T3	500.00
Door switch for light control, 220V-Ith=10A	1 pc (s).	DSW-01	1,450.00

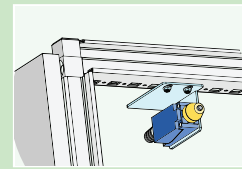
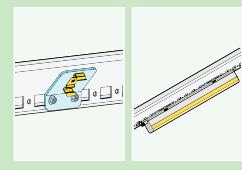

Equipment

- Panel light (Phillips BN058C):** LED type quick and easy installation to enclosure frame lightweight color temp 3000K 90 lumen, can be connected in series for increasing light lumen, lifetime 15,000 Hr.
- Door operated switch (Omron D4MC5000):** For panel light control or signal to other system when door opens.

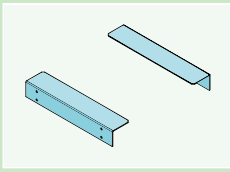

Busbar Bracket Support

For busbar installation

Material

- Aluminium zinc coated steel, 2.0mm.

Supply includes

- Assembly screws

Pack of	Model No.	Unit Price (Baht)
2 pc (s).	BM-275	200.00
2 pc (s).	BM-375	265.00

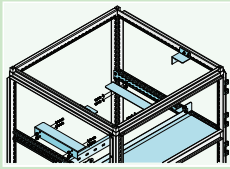

Ground bar bracket

For grounding bar installation

Material

- Aluminium zinc coated steel, 2.0mm.

Supply includes

- Assembly screws

Pack of	Model No.	Unit Price (Baht)
2 pc (s).	GB-01	210.00

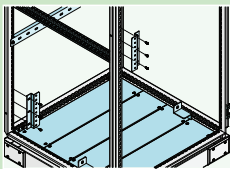
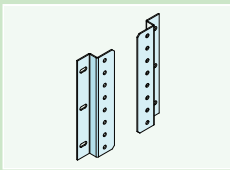

Door stopper

For door stop, latching mechanical

Material

- Galvanized steel

Supply includes

- Assembly screws

Pack of	Model No.	Unit Price (Baht)
1 pc (s).	DS-01	600.00

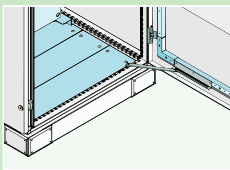

Lifting angle

For transporting by crane, or in the case of bayed enclosure suites, combined with the combination angle.

Material

- Angle iron, 5mm.

Finished surface

- Angle iron: Polyester powder coated in RAL7035

Supply includes

- Assembly screws

For enclosure frame: Width (mm.)	Pack of	Model No.	Unit Price (Baht)
600	2 pc (s).	LA-06	1,000.00
800	2 pc (s).	LA-08	1,350.00
1200	2 pc (s).	LA-12	2,000.00

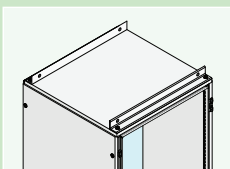

Eye bolts

For transporting by crane

Thread: M12

Supply includes

- 4 pc(s) of Eye bolts

Material	Pack of	Model No.	Unit Price (Baht)
Steel (Yellow zinc coated)	4 pc (s).	EB-M12-YZ	310.00
Stainless steel (SS304)	4 pc (s).	EB-M12-STL	1,700.00

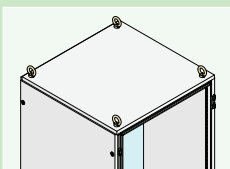

Roof

For outdoor application.

Material

- Steel sheet, 1.5mm.

Finished surface

- Polyester powder coated in RAL7035

Supply includes

- 4 pc(s). Boot for support roof

For enclosure frame: Width x Depth (mm.)	Pack of	Model No.	Unit Price (Baht)
600 x 400	1 set	R-0604	3,800.00
600 x 600	1 set	R-0606	4,300.00
800 x 600	1 set	R-0806	4,900.00
800 x 800	1 set	R-0808	5,550.00
1200 x 400	1 set	R-1204	5,350.00
1200 x 600	1 set	R-1206	6,100.00
1200 x 800	1 set	R-1208	6,950.00

